

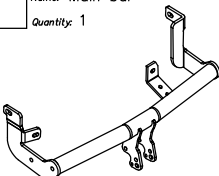

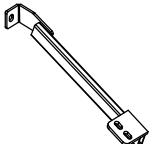







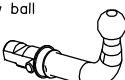





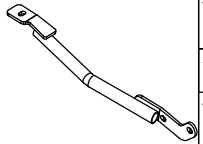

Towbar accessories:

Pos. 1 Name: Main bar Quantity: 1 	Pos. 5 Name: Central bracket Quantity: 1 	Pos. 10 Name: Nut 8 B Quantity: 1 Dim.: M12 	Pos. 16 Name: Spring washer Quantity: 8 Dim.: Ø 10,2 mm 
Pos. 2 Name: Tow ball Quantity: 1 	Pos. 6 Name: Bolt 8,8 B Quantity: 4 Dim.: M12x25mm 	Pos. 11 Name: Washer Quantity: 2 Dim.: Ø35xØ12x3mm 	Pos. 17 Name: Ball cover Quantity: 1 
Pos. 3 Name: Socket plate Quantity: 1 	Pos. 7 Name: Bolt 8,8 B Quantity: 2 Dim.: M12x40mm 	Pos. 12 Name: Washer Quantity: 8 Dim.: Ø30xØ10x3mm 	Pos. 18 Name: Body of the automat Quantity: 1 
Pos. 4 Name: Left bracket Quantity: 1 	Pos. 8 Name: Bolt 8,8 B Quantity: 8 Dim.: M10x35mm 	Pos. 13 Name: Plain washer Quantity: 6 Dim.: Ø 13 mm 	Pos. 19 Name: Body plug Quantity: 1 
	Pos. 9 Name: Coget nut Quantity: 6 Dim.: M10 	Pos. 14 Name: Plain washer Quantity: 8 Dim.: Ø 10,5 mm 	Pos. 15 Name: Spring washer Quantity: 6 Dim.: Ø 12,2 mm 

Towing hitch (without electrical set)

Class: **A50-X** Cat. no. **R17A**

Designed for:

PEUGEOT

- ✓ **806 (5 doors, VAN)**
- ✓ **Expert (metal built-up)**

CITROEN

- ✓ **Evasion (5 doors, VAN)**
- ✓ **Jumpy (metal built-up)**

FIAT

- ✓ **Scudo (metal built-up)**

LANCIA

- ✓ **Z (5 doors, VAN)**

all produced since 1994 till 12.2006 and

FIAT

- ✓ **Ulysse (5 doors, VAN)**

produced since 1994 till 2002

Technical data:

D-value: 10,2 kN

maximum trailer weight: **1800 kg**
maximum vertical cup mass: **80 kg**

Approval number according to Directive 94/20/EC: e20*94/20*0802*00

Foreword

This towbar is designed according to rules of safety traffic regulations. The towing hitch is a safety component and can be install only by qualified personnel. Any alteration or conversion of the towing hitch is prohibited and would lead to cancellation of design certification. Remove insulating compound and underseal from vehicle (if present) in the area of the matting surfaces of the towing hitch.

The vehicle manufacturer's specifications regarding trailer load and max. vertical cup load are decisive for driving, and values for the towing hitch cannot be exceeded.

D-value formula:

$$\frac{\text{Max trailer weight [kg]} \times \text{Max vehicle weight [kg]}}{\text{Max trailer weight [kg]} + \text{Max vehicle weight [kg]}} \times \frac{9,81}{1000} = D \text{ [kN]}$$

FITTING INSTRUCTION

Clamp mark in acc. with		Cables joining
ISO	PN	
1	L	Left directional lights
2	+	Rear fog lights
3	31	Ground
4	R	Right directional lights
5	58R	Right side parking lights
6	54	Stoplights
7	58L	Left side parking lights

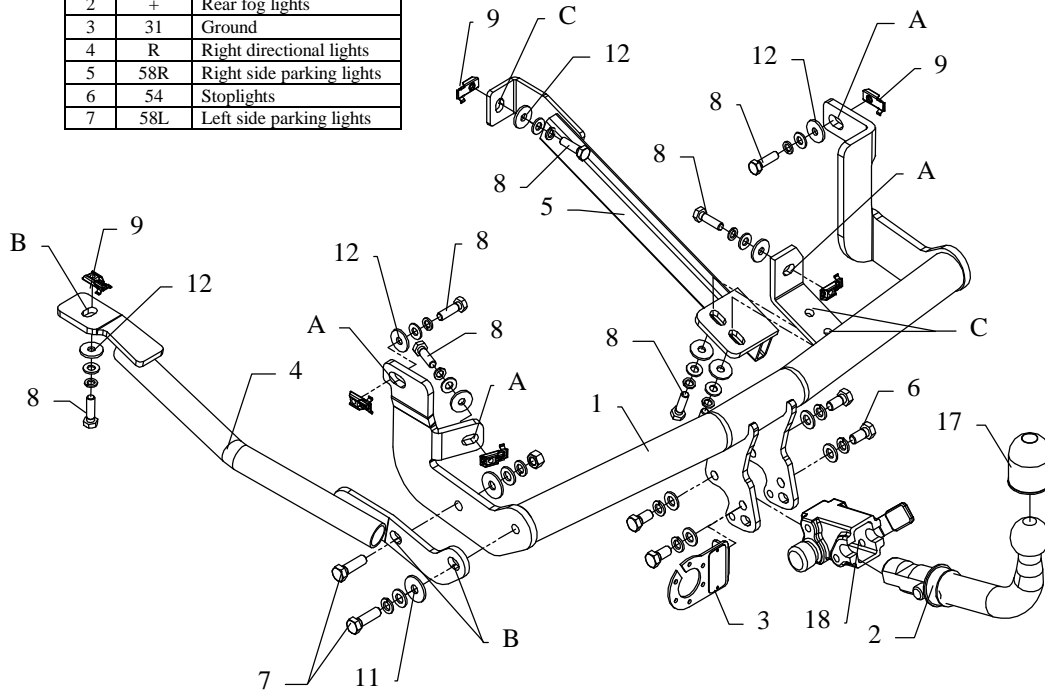

This towbar is designed to assembly in following cars:

PEUGEOT 806 (5 doors and VAN) and EXPERT (metal built-up), CITROEN EVASION (5 doors and VAN) and JUMPY (metal built-up), FIAT SCUDO (metal built-up), LANCIA Z (5 doors and VAN), all produced since 1994 till 12.2006 and **FIAT ULYSSE (5 doors and VAN)** produced since 1994 till 2002, catalogue number **R17A** and is prepared to tow trailers max total weight **1800 kg** and max vertical mass **80 kg**.

From manufacturer

Thank you for buying our product. Their reliability has been confirmed in many tests. Reliability of towbar depends also on correct assembly and correct exploitation. For this reasons we kindly ask to read carefully this instruction and apply to hints.

The towbar should be install in points described by a car producer.

The instruction of the assembly

1. Get lower a spare wheel and exhaust manifold.
2. Make opening in the bumper (in axis): width 80mm, depth 50mm.
3. Put caget nuts (pos. 9) to the chassis members.
4. Fix main bar of the towbar (pos. 1) to chassis members at points A – loosely.
5. Fix side bracket (pos. 4) to the chassis member and to the main bar of the towbar at points B – loosely.
6. Fix central bracket (pos. 5) to the chassis member and to the main bar of the towbar at points C – loosely.
7. Fix body of the automat (pos. 18) and the socket plate (pos. 3) using bolts M12x25mm (pos. 6) from accessories. Place towball (pos. 2) according to supplied instruction.
8. Fix tight all bolts according to the torque shown in the table.
9. Connect electric wires according to the instruction of the car. (Recommend to make at authorized service station)
10. Complete the paint coating damaged during installation.

Torque settings for nuts and bolts (8,8):

M6 - 11 Nm	M8 - 25 Nm	M10 - 50 Nm
M12 - 87 Nm	M14 - 138 Nm	M16 - 210 Nm

NOTE

After install the towbar you should get adequate note in registration book (at authorised service station).The car should be equipped with:

- Indicators
- Tow mirrors

After 1000km of exploitation check all bolts and nuts. The ball of towbar must be always kept clear and conserve with a grease.



ahkupplungen.de