

## FITTING INSTRUCTION

Clamp mark in acc. with		Cables joining
ISO	PN	
1	L	Left directional lights
2	+	Rear fog lights
3	31	Ground
4	R	Right directional lights
5	58R	Right side parking lights
6	54	Stoplights
7	58L	Left side parking lights

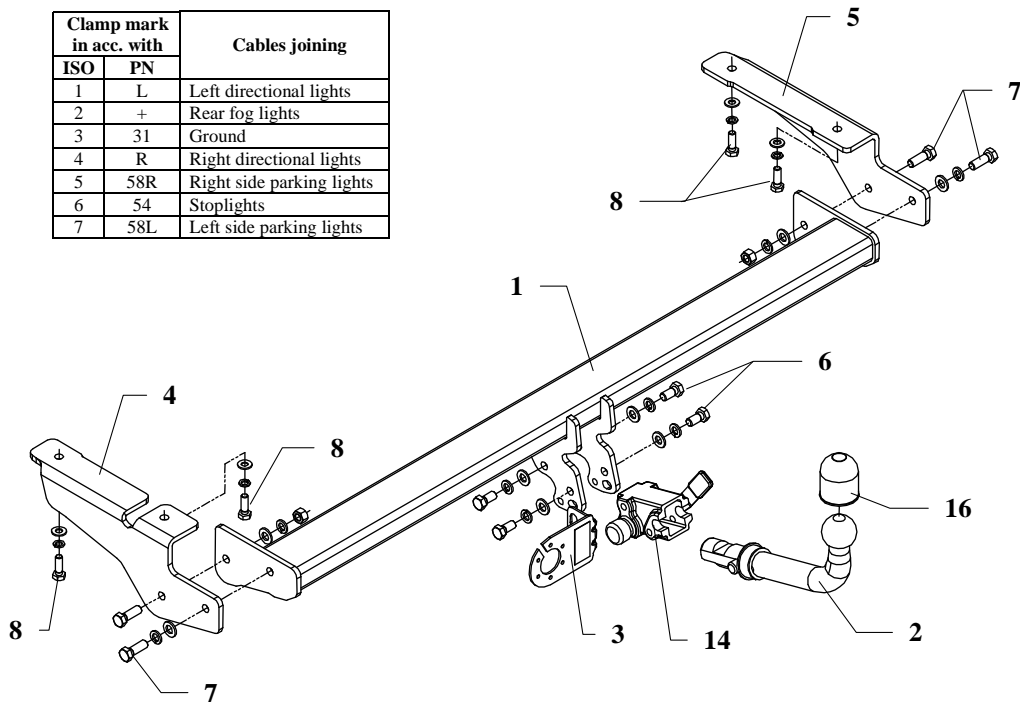

This towbar is designed to assembly in following cars:  
**CITROEN C5 I, 4 doors**, produced since 2000 till 09.2004, catalogue no.  
**P24A** and is prepared to tow trailers max total weight **1600 kg** and max vertical mass **85 kg**.

### *From manufacturer*

Thank you for buying our product. Their reliability has been confirmed in many tests. Reliability of towbar depends also on correct assembly and right operation. For this reasons we kindly ask to read carefully this instruction and apply to hints.

*The towbar should be installing in points described by a car producer.*

## The instruction of the assembly

1. From underside of the bumper disassemble a plastic “spoiler” (it will not be fitted again).
2. Fit loosely side brackets (pos. 4 and 5) in the fabric made holes using bolts M10x30mm (pos. 8)
3. Between fitted side brackets 4 and 5 slide the main bar of towbar (pos. 1) and fix using bolts M12x35mm (pos. 7).
4. Fix body of the automat (pos. 14) and the socket plate (pos. 3) using bolts M12x25mm (pos. 6) from accessories. Place towball (pos. 2) according to supplied instruction.
5. Tighten all nuts and bolts according to the torque shown in the table
6. Connect to the electric wires according to the instructions of the car
7. Complete the paint cover of towbar (during the mounting paint cover could be destroyed).

Torque settings for nuts and bolts (8,8):

<b>M6</b> - 11 Nm	<b>M8</b> - 25 Nm	<b>M10</b> - 50 Nm
<b>M12</b> - 87 Nm	<b>M14</b> - 138 Nm	<b>M16</b> - 210 Nm











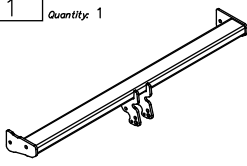
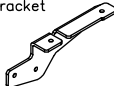

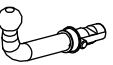

### **NOTE**

After install the towbar you should get adequate note in registration book (at authorised service station).The car should be equipped with:

- Indicators
- Tow mirrors

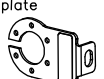
Check all bolts and nuts after 1000km of exploitation. The ball of towbar must be always kept clear and conserve with a grease.

## Towbar accessories:

Pos. 1	Name: Main bar Quantity: 1	Pos. 4	Name: Left bracket Quantity: 1	Pos. 8	Name: Bolt 8,8 B Quantity: 4 Dim.: M10x30mm	Pos. 12	Name: Spring washer Quantity: 8 Dim.: $\phi$ 12,2 mm
							
		Pos. 5	Name: Right bracket Quantity: 1	Pos. 9	Name: Nut 8 B Quantity: 2 Dim.: M12	Pos. 13	Name: Spring washer Quantity: 4 Dim.: $\phi$ 10,2 mm
							
Pos. 2	Name: Tow-ball Quantity: 1	Pos. 6	Name: Bolt 8,8 B Quantity: 4 Dim.: M12x25mm	Pos. 10	Name: Plain washer Quantity: 8 Dim.: $\phi$ 13 mm	Pos. 14	Name: Body of the automat Quantity: 1
							
Pos. 3	Name: Socket plate Quantity: 1	Pos. 7	Name: Bolt 8,8 B Quantity: 4 Dim.: M12x35mm	Pos. 11	Name: Plain washer Quantity: 4 Dim.: $\phi$ 10,5 mm	Pos. 15	Name: Body plug Quantity: 1
							
				Pos. 16	Name: Ball cover Quantity: 1		



## PPUH AUTO-HAK Sp.J.

Produkcja Zaczepów Kulowych  
Henryk & Zbigniew Nejman  
76-200 SŁUPSK ul. Słoneczna 16K  
tel/fax (059) 8-414-414; 8-414-413  
E-mail: [office@autohak.com.pl](mailto:office@autohak.com.pl)  
[www.autohak.com.pl](http://www.autohak.com.pl)

## Towing hitch (without electrical set)

Class: **A50-X** Cat. no. **P24A**

Designed for:

Manufacturer: **CITROEN**

Model: **C5 I**

Type: **4 doors**

produced since 2000 till 09.2004

Technical data:

**D-value: 8,74 kN**

maximum trailer weight: **1600 kg**

maximum vertical cup mass: **85 kg**

**Approval number according to Directive 94/20/EC: e20\*94/20\*0798\*00**

## Foreword

This towing hitch is designed according to rules of safety traffic regulations. The towing hitch is a safety component and can be install only by qualified personnel. Any alteration or conversion of the towing hitch is prohibited and would lead to cancellation of design certification. Remove insulating compound and underseal from vehicle (if present) in the area of the matting surfaces of the towing hitch.

The vehicle manufacturer's specifications regarding trailer load and max. vertical cup mass are decisive for driving whereat values for the towing hitch cannot be exceeded.

*D-value formula:*

$$\frac{\text{Max trailer weight [kg]} \times \text{Max vehicle weight [kg]}}{\text{Max trailer weight [kg]} + \text{Max vehicle weight [kg]}} \times \frac{9,81}{1000} = D \text{ [kN]}$$



[ahkupplungen.de](http://ahkupplungen.de)