

FITTING INSTRUCTION

Clamp mark in acc. with		Cables joining
ISO	PN	
1	L	Left directional lights
2	+	Rear fog lights
3	31	Ground
4	R	Right directional lights
5	58R	Right side parking lights
6	54	Stoplights
7	58L	Left side parking lights

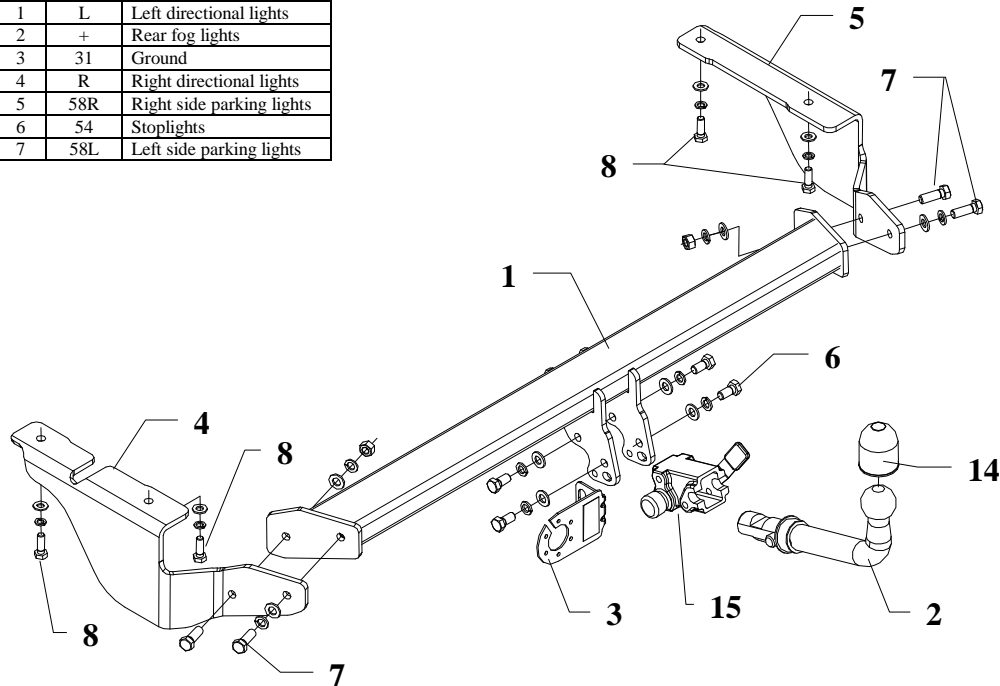

This towbar is designed to assembly in following cars:
CITROEN C5 Estate produced since 2000 till 09.2004, catalogue number **P23A** and is prepared to tow trailers max total weight **1600 kg** and max vertical load **85 kg**.

From manufacturer

Thank you for buying our product. Their reliability has been confirmed in many tests. Reliability of towbar depends also on correct assembly and right operation. For this reasons we kindly ask to read carefully this instruction and apply to hints.

The towbar should be install in points described by a car producer.

Fitting instructions

1. Disassemble the plastic part of the bumper (this part is not used any more)
2. Fix the side brackets (pos. 4 and 5) through the original holes using bolts M10x35mm pos. 8 (do it loosely)
3. Slide the bar of towbar (pos. 1) between fixed side brackets then fix it using bolts M12x35mm (pos. 7).
4. Tighten all nuts and bolts according to the torque shown in the table
5. Fix body of the automat (pos. 15) and the socket plate (pos. 3) using bolts M12x25mm (pos. 6) from accessories. Place tow-ball (pos. 2) according to supplied instruction.
6. Connect the electric wires according to the instructions of the car.
7. Complete the paint cover of towbar (during the mounting paint cover could be destroyed).

Torque settings for nuts and bolts (8,8):

M6 - 11 Nm	M8 - 25 Nm	M10 - 50 Nm
M12 - 87 Nm	M14 - 138 Nm	M16 - 210 Nm











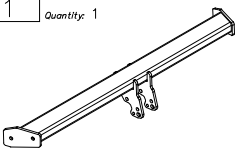

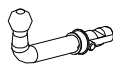

NOTE

After install the towbar you should get adequate note in registration book (at authorised service station).The car should be equipped with:

- Indicators
- Tow mirrors

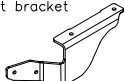
After 1000km of exploitation check all bolts and nuts. The ball of towbar must be always kept clear and conserve with a grease.

Towbar accessories:

Pos. 1 Name: Main bar Quantity: 1	Pos. 5 Name: Left bracket Quantity: 1	Pos. 10 Name: Plain washer Quantity: 8 Dim.: \varnothing 13 mm	Pos. 15 Name: Body of the automat Quantity: 1
			
Pos. 2 Name: Tow ball Quantity: 1	Pos. 6 Name: Bolt 8,8 B Quantity: 4 Dim.: M12x25mm	Pos. 11 Name: Plain washer Quantity: 4 Dim.: \varnothing 10,5 mm	Pos. 16 Name: Body plug Quantity: 1
			
Pos. 3 Name: Socket plate Quantity: 1	Pos. 7 Name: Bolt 8,8 B Quantity: 4 Dim.: M12x35mm	Pos. 12 Name: Spring washer Quantity: 8 Dim.: \varnothing 12,2 mm	
			
Pos. 4 Name: Right bracket Quantity: 1	Pos. 8 Name: Bolt 8,8 B Quantity: 4 Dim.: M10x30mm	Pos. 13 Name: Spring washer Quantity: 4 Dim.: \varnothing 10,2 mm	
			
	Pos. 9 Name: Nut 8 B Quantity: 2 Dim.: M12	Pos. 14 Name: Ball cover Quantity: 1	
			



PPUH AUTO-HAK Sp. J.

Produkcja Zaczepów Kulowych
Henryk & Zbigniew Nejman
76-200 SŁUPSK ul. Słoneczna 16K
tel/fax (059) 8-414-414; 8-414-413
E-mail: office@autohak.com.pl
www.autohak.com.pl

Towing hitch (without electrical set)

Class: **A50-X** Cat. no. **P23A**

Designed for:

Manufacturer: **CITROEN**

Model: **C5 I**

Type: **ESTATE**

produced since 2000 till 09.2004

Technical data:

D-value: 8,99 kN

maximum trailer weight: **1600 kg**

maximum vertical cup load: **85 kg**

Approval number according to Directive 94/20/EC: e20*94/20*0799*00

Foreword

This towing hitch is designed according to rules of safety traffic regulations. The towing hitch is a safety component and can be install only by qualified personnel. Any alteration or conversion of the towing hitch is prohibited and would lead to cancellation of design certification. Remove insulating compound and underseal from vehicle (if present) in the areas of the matting surfaces of the towing hitch. The vehicle manufacturer's specifications regarding trailer load and max. vertical cup mass are decisive for driving whereat values for the towing hitch cannot be exceeded.

D-value formula:

$$\frac{\text{Max trailer weight [kg]} \times \text{Max vehicle weight [kg]}}{\text{Max trailer weight [kg]} + \text{Max vehicle weight [kg]}} \times \frac{9,81}{1000} = D \text{ [kN]}$$



ahkupplungen.de