

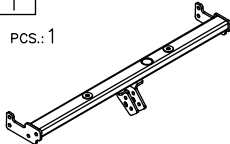









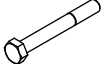





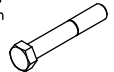

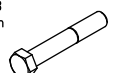
Towing hitch accessories:

Pos. 1 Main bar PCS.: 1 	Pos. 5 Distance sleeve I ø17,2x2,35mm L=52mm PCS.: 4 	Pos. 10 Bolt 8,8 B M10x80mm PCS.: 4 	Pos. 15 Plain washer ø10,5mm PCS.: 12 
	Pos. 6 Distance sleeve II ø17,2x2,35mm L=45mm PCS.: 2 	Pos. 11 Bolt 8,8 B M10x30mm PCS.: 6 	Pos. 16 Spring washer ø12,2mm PCS.: 2 
Pos. 2 Tow ball PCS.: 1 	Pos. 7 Bolt 8,8 B M12x75mm PCS.: 1 	Pos. 12 Cut washer ø58xø12x6mm PCS.: 4 	Pos. 17 Spring washer ø10,2mm PCS.: 12 
	Pos. 8 Bolt 8,8 B M12x70mm PCS.: 1 	Pos. 13 Plain washer ø30xø10,5x2,5mm PCS.: 2 	Pos. 18 Nut 8 B M12 PCS.: 2 
Pos. 3 Socket plate PCS.: 1 	Pos. 9 Bolt 8,8 B M10x110mm PCS.: 2 	Pos. 14 Plain washer ø13mm PCS.: 2 	Pos. 19 Nut 8 B M10 PCS.: 12 
	Pos. 4 Side bracket PCS.: 2 	Pos. 20 Ball cover PCS.: 1 	



PPUH AUTO-HAK Sp.J.

Produkcja Zaczepów Kulowych
Henryk & Zbigniew Nejman
76-200 SŁUPSK ul. Słoneczna 16K
tel/fax (059) 8-414-414; 8-414-413
E-mail: office@autohak.com.pl
www.autohak.com.pl

Towing hitch (without electrical set)

Class: **A50-X** Cat. no. **P06**

Designed for:

Manufacturer: **CITROEN**

Model: **C15**

produced since 1985 till 2007

Technical data:

D-value: 5,6 kN

maximum trailer weight: **900 kg**

maximum vertical cup load: **45 kg**

Approval number according to Directive 94/20/EC: e20*94/20*0316*00

Foreword

This towing hitch is designed according to rules of safety traffic regulations. The towing hitch is a safety component and can be install only by qualified personnel. Any alteration or conversion of the towing hitch is prohibited and would lead to cancellation of design certification. Remove insulating compound and underseal from vehicle (if present) in the area of the matting surfaces of the towing hitch. The vehicle manufacturer's specifications regarding trailer load and max. vertical cup load are decisive for driving whereat values for the towing hitch cannot be exceeded.

D-value formula:

$$\frac{\text{Max trailer weight [kg]} \times \text{Max vehicle weight [kg]}}{\text{Max trailer weight [kg]} + \text{Max vehicle weight [kg]}} \times \frac{9,81}{1000} = D \text{ [kN]}$$

FITTING INSTRUCTION

Clamp mark in acc. with		Cables joining
ISO	PN	
1	L	Left directional lights
2	+	Rear fog lights
3	31	Ground
4	R	Right directional lights
5	58R	Right side parking lights
6	54	Stoplights
7	58L	Left side parking lights

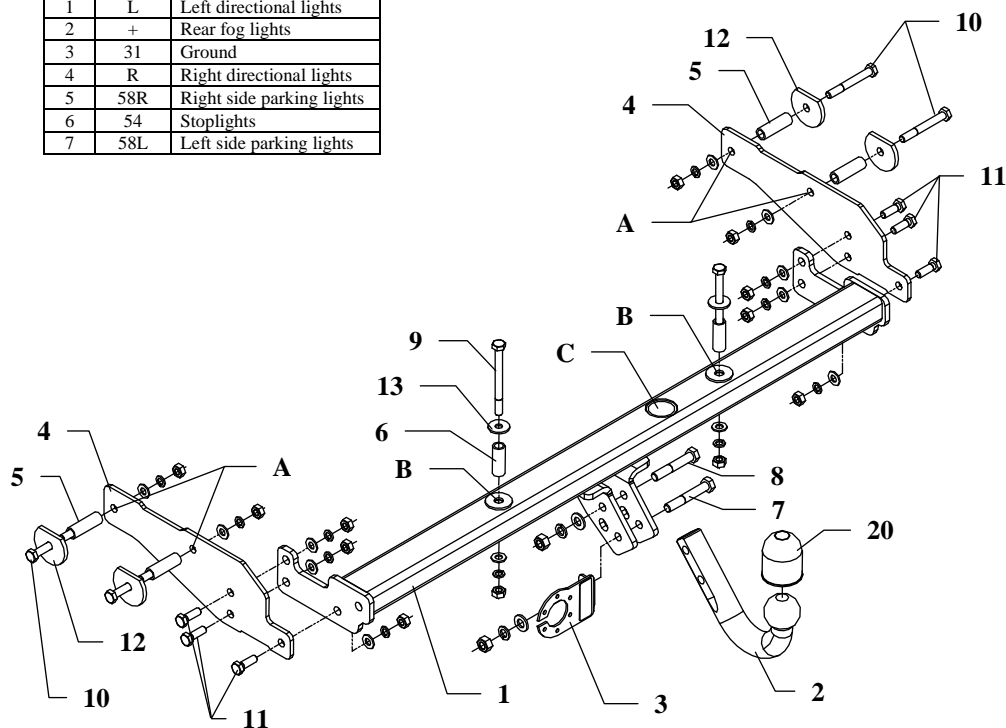

This towing hitch is designed to assembly in following car: **CITROEN C15**, produced since 1985 till 2007, catalogue no. **P06** and is prepared to tow trailers max total weight **900 kg** and max vertical load **45 kg**.

From manufacturer

Thank you for buying our product. Their reliability has been confirmed in many tests. Reliability of towing hitch depends also on correct assembly and right operation. For this reasons we kindly ask to read carefully this instruction and apply to hints.

The towing hitch should be install in points described by a car producer.

The instruction of the assembly

- To install the towing hitch disassemble the spare wheel and hook of basket of spare wheel.
- To existing holes in left and right chassis member put per two distance sleeves length 52mm (pos. 5) from accessories, then through this sleeves and holes pos. A fix side brackets (pos. 4) using bolts M10x80mm (pos. 10), use big cut washers $\varnothing 58$ mm (pos. 12).
- Between installed side brackets fix main bar of the towing hitch (pos. 1) using bolts M10x30mm (pos. 11).
- Underneath the main bar through holes pos. B drill holes inside the trunk using bit $\varnothing 10,5$ mm. (first open the rear door)
- From inside of the trunk enlarge this holes using bit $\varnothing 17,5$ mm. Then put distance sleeves length 45mm (pos. 6) and fix using bolts M10x110mm (pos. 9).
- To install the spare wheel put hook of basket in hole pos. C in main bar.
- Fix tow-ball (pos. 2) with socket plate (pos. 3) using bolts M12x75mm (pos. 7) and M12x70mm (pos. 8) from accessories.
- Tighten all bolts according to the torque shown in the table.
- Connect electric wires of 7-poles socket according to the instruction of the car. (Recommend to make at authorized service station).
- Complete paint layer damaged during installation.

Torque settings for nuts and bolts (8,8):

M6 - 11 Nm	M 8 - 25 Nm	M 10 - 50 Nm
M 12 - 87 Nm	M 14 - 138 Nm	M16 - 210 Nm

NOTE

After install the towing hitch you should get adequate note in registration book (at authorised service station).The car should be equipped with:

- Indicators
- Tow mirrors

After 1000km of exploitation check all bolts. The ball of towing hitch must be always kept clear and conserve with a grease.



ahkupplungen.de